

# Installation and Maintenance Manual

## *Sliding Gate Operators*

Inbuilt Models: GDS 450LI & 630LI Range

*Made in Australia from Australian & quality imported components*



8 Bennet Avenue Melrose Park SA 5039  
Phone 08 8374 3466

A.B.N. 62 059 806 405  
July 2014



N14870

# Quick start instructions

(For those who don't have time!)

## *Sliding Gate Operators*

### GDS 450, 630 "LI" Range

*Made in Australia from Australian & quality imported components*

Place operator in correct position (Pinion wheel to be parallel to the gate and stepped out to allow for width of rack once it is mounted onto the gate frame). Mark out fixings and fix operator to the concrete pad.



Fix rack to the gate frame keeping 1mm-2mm clearance between the rack teeth and Pinion wheel

Once the rack is fixed move the gate and sight the rack moving over the pinion wheel, check that most of the pinion wheel meshes with the rack. Make sure rack runs freely over the pinion wheel, any tight spots should be corrected by adjusting the rack height. Check the operator is firmly bolted down to the concrete pad.



Ensure stops are installed on the gate for the fully closed and fully open positions.

Connect required P.E Beams. Adjust Limits to actuate prior to gate end positions. Connect power supply. Turn on Power. Observe that the M1 op and cl limit indicator led's turn off when the corresponding limit switch is activated. If they are the wrong way around, swap the op and cl limit wires around.

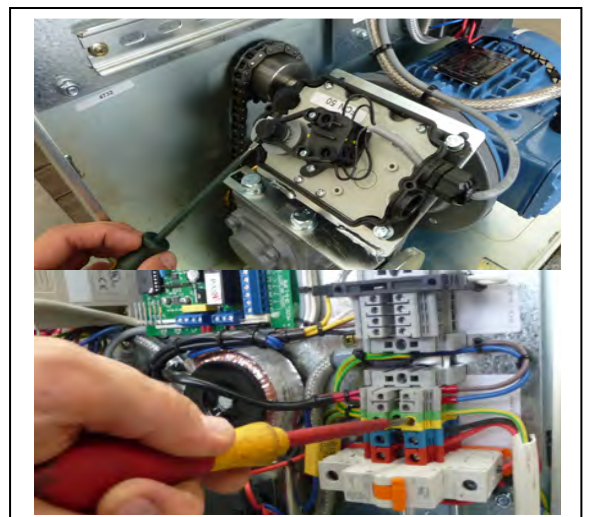

To commission the gate, move the gate to approximately the half way position, tighten the knurled wheel (Clockwise) engaging the clutch just enough to drive but will still slip if the gate hits something while travelling at high speed. **The clutch must be tightened up fully after commissioning.**

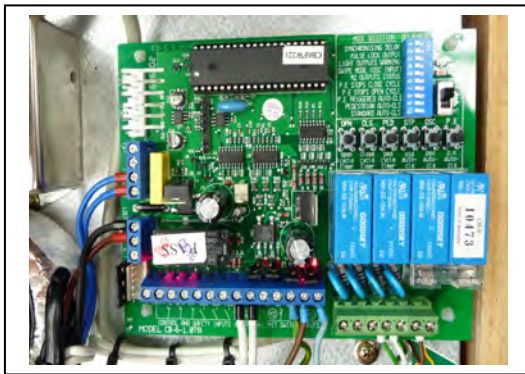

Press the opn button located under the dip switches to begin opening cycle.

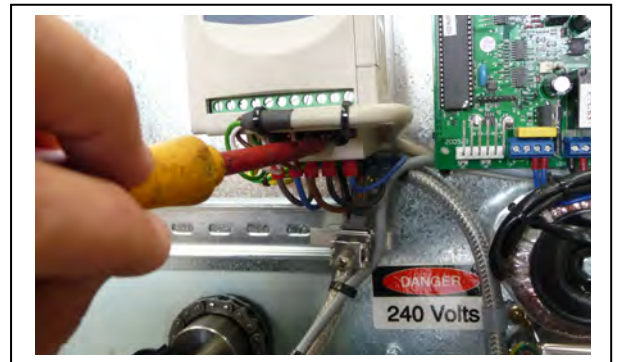

**Ensure** the direction the gate travels is in accordance with the opening and closing status LED's, if not reverse two of the motor wires at the inverter terminals.



Inverter settings can be adjusted via the keypad i.e. Opening speed, closing speed and ramp times. Automation settings operating modes are able to be adjusted via the CB6 board, refer to manual for further instructions.

Once Inverter settings are appropriately set proceed to make final adjustments to the limits. They need to be set so that they switch prior to the gate reaching its full open and close positions, initiating the ramp down period so the gate will slow down to a complete stop at its final position. Once set, proceed with the gate travel timing via the run/set switch, then firmly tighten the clutch.

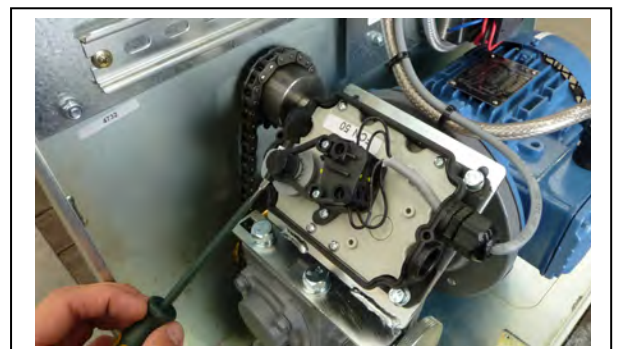

# CONTENTS

Section No:		Page No:
	Quick start instructions	2-3
1	Safety Precautions	5
2	Wiring Requirements	6
3	Installation Electrical Cabling Mechanical Installation Electrical Connections Plan view layout/ conduit positions CB6 Control Board layout CB-6 Control inputs / mode settings	6-10
4	Variable Speed Drive (VSD)	11
5	Commissioning	11
6	Control diagrams	12
7	Manual Release Instructions	13
8	Maintenance	14
9	Warranty	15



## 1. SAFETY PRECAUTIONS



**WARNING!** FAILURE TO FOLLOW THESE SAFETY PRECAUTIONS AND INSTALLATION INSTRUCTIONS COULD RESULT IN INJURY OR DEATH AND/OR DAMAGE TO PROPERTY AND EQUIPMENT.

- Appropriately licensed and competent personnel only should install the automation equipment.
- The operators are designed specifically to open and close sliding gates or doors and should not be used for any other purpose.
- Before commencing installation, read through this installation manual.
- Check that the operator and controls are in new condition and have not been damaged in transit.
- Check the gate or door and it's associated support posts and walls to protect against shearing, compression and other various traps which could cause serious injury or death. Take into consideration the general installation and surrounding environment.
- Check the gateposts or mounting structure has the necessary strength and rigidity to support the operator and the load of the opening and closing gate motion.

**CAUTION!**



**Always incorporate the appropriate Photo Electric Cells, Induction Loops and any other safety devices to protect both equipment and personnel. Extra caution should be employed when using operator in auto close mode.**

- Display any necessary signs to indicate any danger areas and automatic operation of the gate or door.
- The operators are not designed to be used in any hazardous areas or areas subject to flooding etc.
- All electrical connections and wiring must be performed with AS/NZS 3000-2007 as the guidelines. (Or its counterpart for other countries outside of Australia and New Zealand)

**WARNING! ELECTRICITY CAN KILL**

- The manufacturer of the automation equipment is not responsible for the damage which may be caused to either the operator, gate or door and any other person or equipment when:
  - Wrong or poor installation practices were performed.
  - No or inadequate safety devices were used.
  - Either the surrounding structure or the gate or door strength and rigidity was not sufficient for the task in hand.
  - Inefficient locking devices were employed.
  - Poor maintenance on the equipment.
  - Any other circumstances beyond the manufacturers control.
- Isolate power before attempting any maintenance, qualified personnel only to carry out maintenance
- Only original spare parts are to be used should there be a requirement for them.
- Keep loose clothing and hands clear of the gate whilst in operation or potentially able to be operated.
- The installer should provide all information concerning the use of the automation equipment as well as instructions regarding the manual override and maintenance procedures to the users of the system.

## 2. WIRING REQUIREMENTS

- **Single phase 240v 10A non-earth leakage protected power supply to where operator is mounted.**  
**\*This is required because inverter VSD drive units inherently allow an earth leakage current to flow. This current is minimal but a non RCD protected circuit must be installed and the method of installation done so in accordance AS/NZS 3000:2007 to comply.**  
**A connection made to an earth leakage protected circuit may cause nuisance tripping.**
- Extra Low Voltage cables from operator for access control. (Shielded cable if over 8m runs).

## 3. INSTALLATION DETAILS

After reading the previous sections in this manual, and having checked for suitable installation, proceed as follows:-

### Electrical Cabling

- A suitably rated Isolator and 240v power supply should be available near to where the gate operator is to be mounted. The following diagrams will provide measurements for the positioning of conduits and the appropriate position for mounting the operator whether a GDS 450,500,630 LI or P type.
- **When bringing power and control cables into the control enclosure inside the operator, please leave enough slack in the cables, in this way, the enclosure can still be lifted up in order to see and work on the controls easier. To lift up control enclosure, undo wing nut on right hand side, once lifted up, re tighten the nut to keep enclosure in upwards position, once finished, undo nut, drop enclosure back down, then re tighten wing nut.**

### Mechanical Installation

- Ensure gate rolls easily and has been installed in a manner where there is no excessive friction or binding occurring.
- A concrete base approximately 600mm long x 300 wide x 300mm deep should be laid where the gate operator is to be located.
- **IMPORTANT** ensure there are gate stops firmly installed in the fully open and closed positions. These stops need to be engineered and installed such that they will be strong enough to stop the gate should the limits fail at any time.
- Remove the gate operator cover and position mounting plate and operator in approximate mounting location.
- Use the rack to locate the operator the correct distance away from the gate rail (finer adjustment can be made after).
- Dynabolt or chemical anchor the bottom mounting plate to the concrete mounting pad using 12 x 100mm fixings.
- Unscrew anticlockwise the manual disconnect knurled knob so the drive gear free wheels.
- Fix the rack to the gate rail ensuring there is approximately 1mm - 2mm gap between the meshing of the teeth of the rack and the drive gear (no more). Move the gate by hand from one end to the other while checking that the rack is meshing correctly with the drive gear on the operator. Check also that the rack is centred around the middle of the teeth on the drive cog – tighten the mounting plate nuts.

### Electrical Connections

- Connect a non earth leakage protected 10A 240v supply to Din Rail terminals labelled A & N, Connect earth to the earth Din Rail terminal.
- Conduits for power & control need to preferably come up through the base plate 'knockout'.

GDS 450,500,630 LI-PI Plan View Right Opening

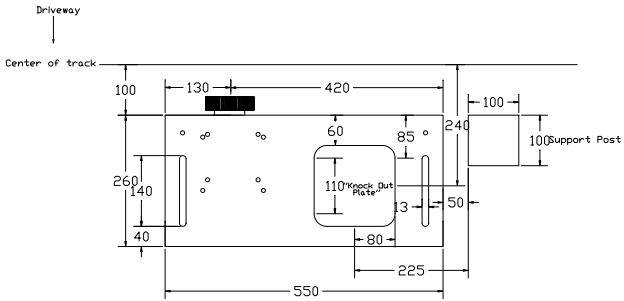

PLAN VIEW

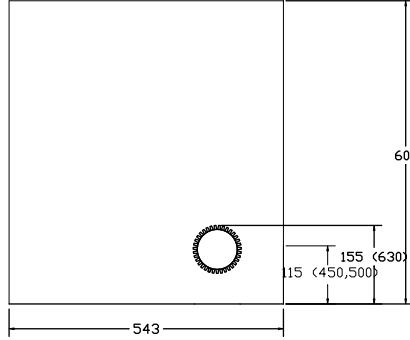

BACK VIEW

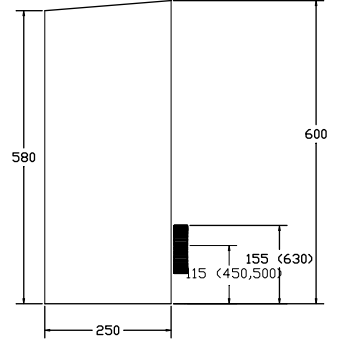

SIDE VIEW

NOTES:

- THESE MEASUREMENTS ARE ONLY APPLICABLE WHEN USING A 100x100 GATE FRAME
- THIS DRAWING IS FOR A GATE THAT OPENS TO THE RIGHT WHEN LOOKING FROM THE ROAD INTO THE PROPERTY
- WITH THIS GATE OPENING SCENARIO, THE CENTER POSITION OF THE CONDUIT ENTRY IS 225mm FROM THE SUPPORT POST AND 240mm FROM THE CENTER OF THE TRACK

GDS 450,500,630 LI-PI Plan View Right Opening

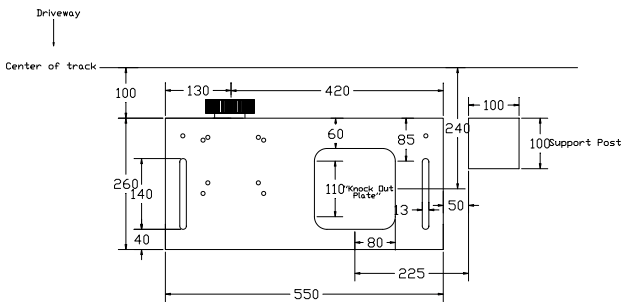

PLAN VIEW

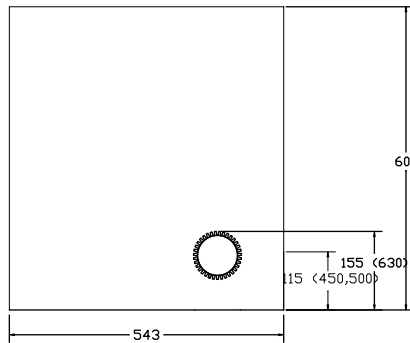

BACK VIEW

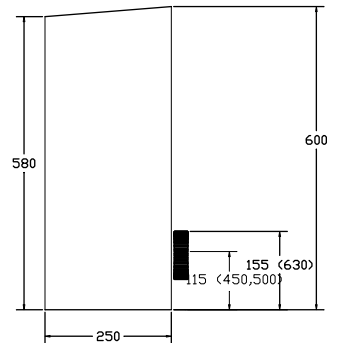

SIDE VIEW

NOTES:

- THESE MEASUREMENTS ARE ONLY APPLICABLE WHEN USING A 100x100 GATE FRAME
- THIS DRAWING IS FOR A GATE THAT OPENS TO THE RIGHT WHEN LOOKING FROM THE ROAD INTO THE PROPERTY
- WITH THIS GATE OPENING SCENARIO, THE CENTER POSITION OF THE CONDUIT ENTRY IS 225mm FROM THE SUPPORT POST AND 240mm FROM THE CENTER OF THE TRACK

# CB-6 BOARD LAYOUT FOR INVERTER CONTROLS

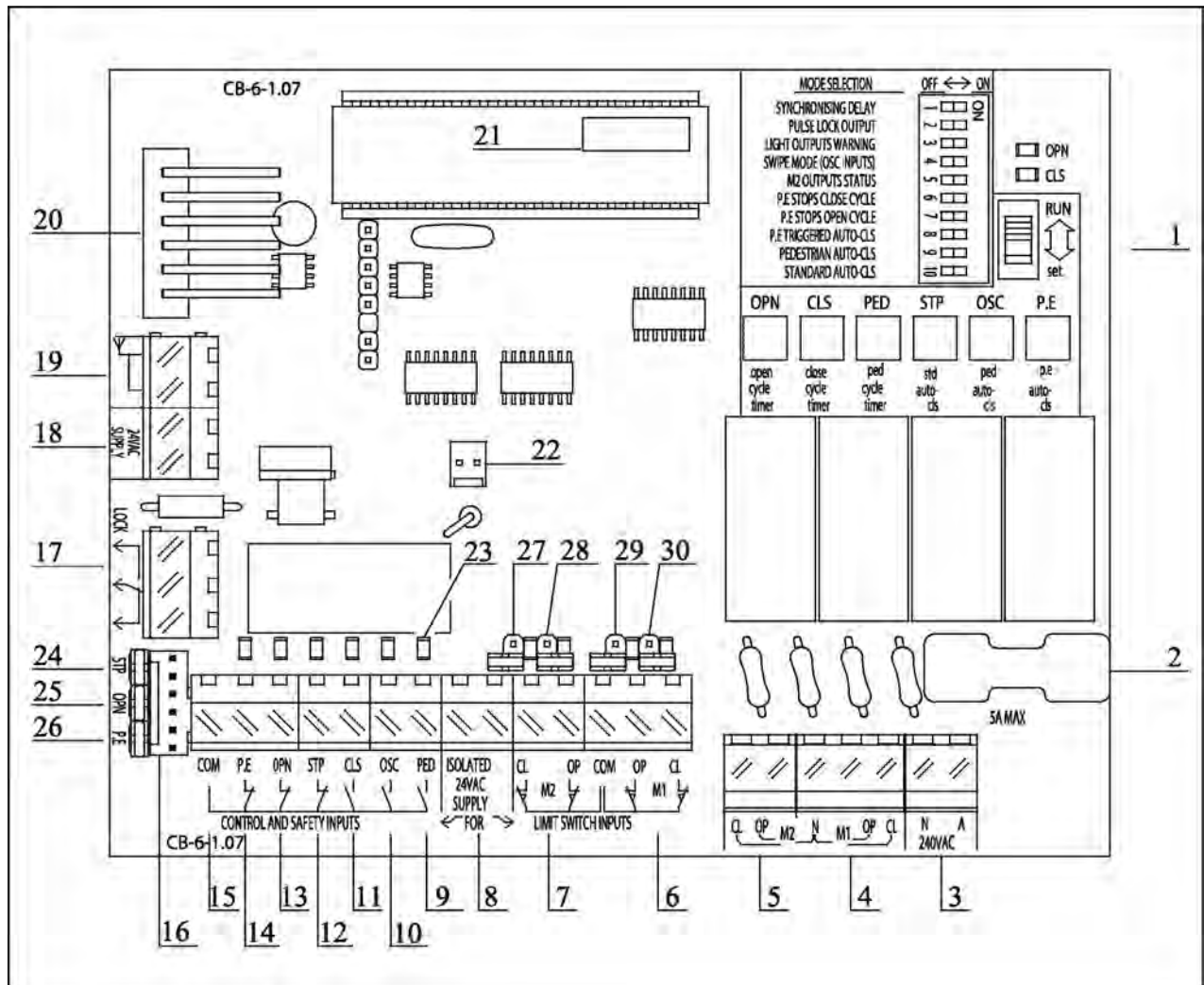

- |  |   |
|--|---|
| <ol style="list-style-type: none"> <li>1. Mode Selection and Adjustment</li> <li>2. Protection Fuse</li> <li>3. Inverter Input Terminals</li> <li>4. Motor 1 Drive Output Terminals for Inverter</li> <li>5. Motor 2 Drive Output Terminals for Inverter</li> <li>6. Motor 1 Limit Switch Inputs</li> <li>7. Motor 2 Limit Switch Inputs</li> <li>8. Terminals for Isolated 24vAC Supply for Limit Switch and Control Inputs</li> <li>9. Pedestrian Access Control Input</li> <li>10. Open/Stop/Close Control Input</li> <li>11. Close Control Input</li> <li>12. Stop Control Input</li> <li>13. Open Control Input</li> <li>14. Photoelectric Safety Beam Input</li> <li>15. Common Terminal for Inputs [9] Thru [14].</li> <li>16. Control Input Harness Connector</li> </ol> | <ol style="list-style-type: none"> <li>17. Electric Lock Control Terminals</li> <li>18. Terminals for 24vAC Supply for Control Logic</li> <li>19. Plug In Receiver Antenna Terminals With Optional Shield</li> <li>20. Connector for Plug-In Receiver (not shown)</li> <li>21. Firmware Version Label</li> <li>22. Light Control Relay Interface Connector</li> <li>23. Input Status L.E.Ds.</li> <li>24. Stop Input Jumper</li> <li>25. Open Input Jumper</li> <li>26. PE Beam Input Jumper</li> <li>27. M2 Close Limit Jumper</li> <li>28. M2 Open Limit Jumper</li> <li>29. M1 Close Limit Jumper</li> <li>30. M1 Open Limit Jumper</li> </ol> |
|--|---|



## Control Inputs / Mode Settings

### Control Inputs

The P.E, OPN and STP inputs require a normally closed switch contact and therefore should be shorted to the COM terminal if not used. This is done via bridging links already on the circuit board (bottom left corner) The CLS, OSC and PED inputs require a normally open switch contact and therefore should be left unconnected if not used. All the switch inputs of this control board including the limit switch inputs require a switch contact only. Do not connect any switches which provide a voltage to the control board as this will damage the control board. If the desired inputs are 12/24v or has long wiring associated with it use an IM-1 module to isolate it from the control board's input. The IM-1 is available from the manufacturer.

### Powering Accessories

Accessories which require a 24v AC supply can be powered from the transformer output used to power the control board via the isolated 24v AC supply which is connected to the DIN rail terminals as labelled. However, the transformer's current capacity must be checked to allow for the extra power required by the accessories. Never use the supply connected to the 24v AC supply control board terminals to power any accessory as this can interfere with the control boards operation. (Blue Wires)

### Locks & Lights

Use the lock output terminals on the din rail to switch the 12 volts to an electric lock (if fitted). The load switched by the lock output terminals must not exceed 30V A.C / D.C @ 5Amps. If an electromagnetic lock is used, change one wire on the control board lock output to the normally closed output. Use the light relay module (if fitted) to switch the applied voltage to a light. The load switched by the light relay module must not exceed 240V A.C / 30V D.C @ 10 Amps.

### Mode Selection

Using the mode selection dip-switches select the desired operating modes. Note the times associated with the parameters marked with an \* can be changed. The auto-close times can be changed using the procedure in the following section. See the instruction manual for details on how to change the other parameters. See the detailed instruction manual for details on how to change the other parameters.

#### Position 1 SYNCHRONISING DELAY

OFF - No delay

ON - Motor 1 starts to open 2 seconds\* before Motor 2 and Motor 2 starts to close 2 seconds\* before Motor 1.

#### Position 2 PULSE LOCK OUTPUT

OFF - Lock output is activated for the entire motor drive cycle.

ON - Lock output pulses for 0.3 seconds\* at the start of each drive cycle.

#### Position 3 LIGHT OUTPUTS WARNING

OFF - Optional light module controls a light with timer which turns light off after 60seconds\*.

ON - Optional light module controls a warning light which activates whenever motors are on.

#### Position 4 SWIPE MODE (OSC INPUT)

OFF - OSC input terminal has standard Open, Close, Stop action.

ON - OSC input terminal will only open the door/gate. The input also resets the P.E triggered auto-close mode so that the P.E input will need to be triggered again before a P.E auto-close cycle will be initiated.

#### Position 5 M 2 OUTPUTS STATUS

OFF - The M2 output controls second motor

ON - The M2 output controls status lights

Position 6 P.E STOPS CLOSE CYCLE

OFF - Activating the P.E input while motors are closing causes the motors to reverse.

ON - Activating the P.E input while motors are closing causes the motors to stop but not reverse.

Position 7 P.E STOPS OPEN CYCLE

OFF - Activating the P.E input while motors are opening is ignored by the controller.

ON - Activating the P.E input while motors are opening causes the motors to stop.

Position 8 P.E TRIGGERED AUTO-CLS

OFF - Not selected

ON - Selects the P.E triggered auto-close mode which causes the motors to auto-close if the P.E input is activated then released. (Auto-close delay time is 0 seconds\*)

Position 9 PEDESTRIAN AUTO-CLS

OFF - No pedestrian access auto-close

ON - Selects auto-close in the pedestrian access mode. (Auto-close delay time is 15 seconds\*)

Position 10 STANDARD AUTO-CLS

OFF - Not selected

ON - Selects standard auto-close mode which will close the motors after fully opening. (Auto-close delay time is 30 seconds\*)

### **Setting Cycle Timers & Auto Close Times**

The control board has pre-set cycle times which are used to set the maximum time the controller will drive the motors in the open and closed directions. The pre-programmed time for the open and close cycle timer's is 60 seconds. The control board also has a pre-set pedestrian access time of 5 seconds which is intended to open the motor connected to M1 output only part way. If these default times do not suit your needs simply use the procedure below to adjust them. Note the same procedure can be used to adjust the auto-close times.

1. Place the slide switch into the "set" position
2. Adjust the timer's value by pressing and holding the required push button for the desired time.
3. Repeat step 2 for the next timer (if desired).
4. Place the slide switch back into the "RUN" position.
5. Test operation.

Make sure that the slide switch is placed back into the "RUN" position before testing the new timer value.

As you can see the procedure used to set each timer's value is the same only the push button used changes. Each push button is clearly labelled underneath as to which timer's value it sets. Note when setting the OPEN, CLOSE and PEDESTRIAN cycle times the controller will drive the motors as if a "real" cycle is being executed. The difference being that the motors will stop as soon as the button is released or the limit switches are reached. The OPN status LED on the control board will flash at 1 second intervals to assist setting times. Note when setting the OPEN and CLOSE cycle times when limit switches are used, release the push button a few seconds after the limit switch cuts motor power. This allows for the motors to slow down over the life of the operators without the need to adjust again.

#### 4. VARIABLE SPEED DRIVE UNIT (VSD)

- The variable speed drive unit will, ramp up the speed of the operator and then ramp down prior to closing.
- It must be remembered that the limit switches are to be set in a position which initiates the ramp down time. Therefore, the limit switches need to operate much sooner than when there is no variable speed drive unit.
- The accelerate and decelerate times have been set in the factory for the normal installation but can be changed if necessary. Similarly, the speed that the gate operates at has also been set but can be changed (up to approx 70Hz).
- NOTE changing the speed will change the position the gate will end up in its fully closed and open position. (Unless limit switch cams are also adjusted accordingly).
- Accelerate time (FN01)                      5 sec
- Decelerate time (FN02)                      2.5 sec
- Closing Speed (FN08)                      40Hz
- Running Frequency                      60Hz
- To change accelerate time: Press DSP/FUN button
- Use arrows to select FN01
- Press DATA/ENT
- Use arrows to select new time
- Press DATA/ENT
- Press DSP/FUN
- To change decelerate time: as above except select FN02
- To change closing speed: as above except select FN08. If opening speed and closing speed is to be the same, remove wire link between REV and SP1 terminals on inverter.
- To change opening speed of operator: when display is flashing and showing Hz, use arrows to raise or lower the Hz figure.
- NOTE frequency upper limit has been set to 70Hz and lower limit 30Hz.

#### 5. COMMISSIONING

- Check that the limit switches are the correct way around by observing that the M1 op and cl indicator led`s go out when the corresponding limit switch is activated. If they are the wrong way around, swap over the M1 op and cl limit wires. They can be roughly set so they activate approx 500 to 800mm before the gate reaches its end stops. Final adjustments can be made later.
- Position the gate halfway and turn the knurled knob clockwise until the clutch is firm enough that the gate will drive, but the clutch will slip if it hits something at high speed.
- Power up board and with gate in the half way position, press the opn or cls buttons to drive the gate
- The corresponding ( green for open and red for close) led should start to flash, if they are the wrong way around, turn power off to the operator, wait until the inverter powers down, then swap over any 2 of the motor phase wire at the inverter. Turn power back on and test.
- Run the gate again fully in each direction checking the limit switch positions.
- Limit switches initiate the ramp down time so should not switch off the gates too soon (before reaching conversely not too late, so the torque limiter is operating. Any speed or ramp time adjustments made from now on will affect the final stop position of gate.
- Tighten clutch ( torque limiter) knurled knob.
- Set open & closed travel time as detailed in **Setting Cycle Timers & Auto Close Times** section.
- Check that all safety devices work as designed.
- Install cover using screws provided in the front and sides to hold cover firm.
- Provide full details to the owner concerning the operation and relevant maintenance and disconnect details.

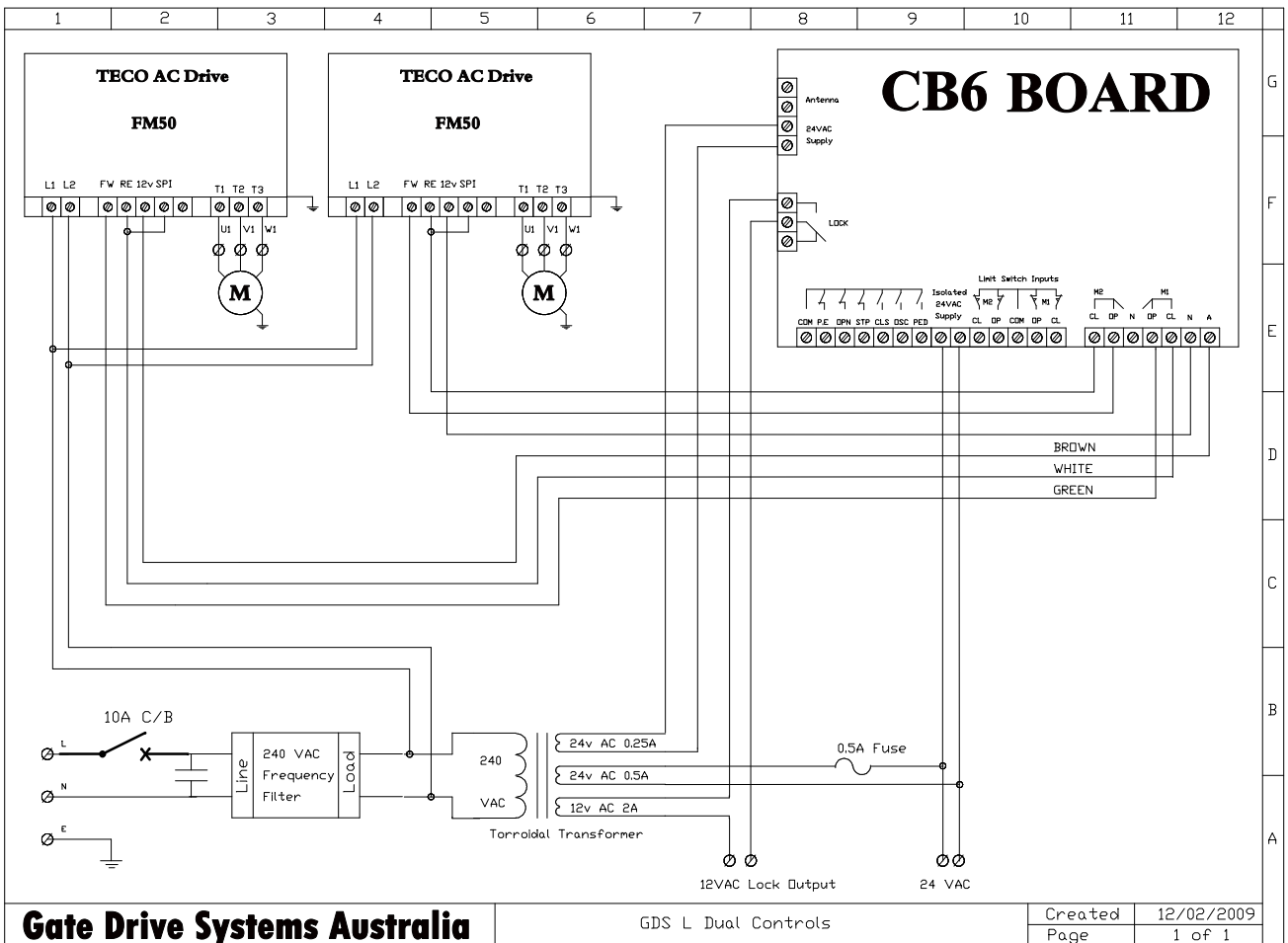
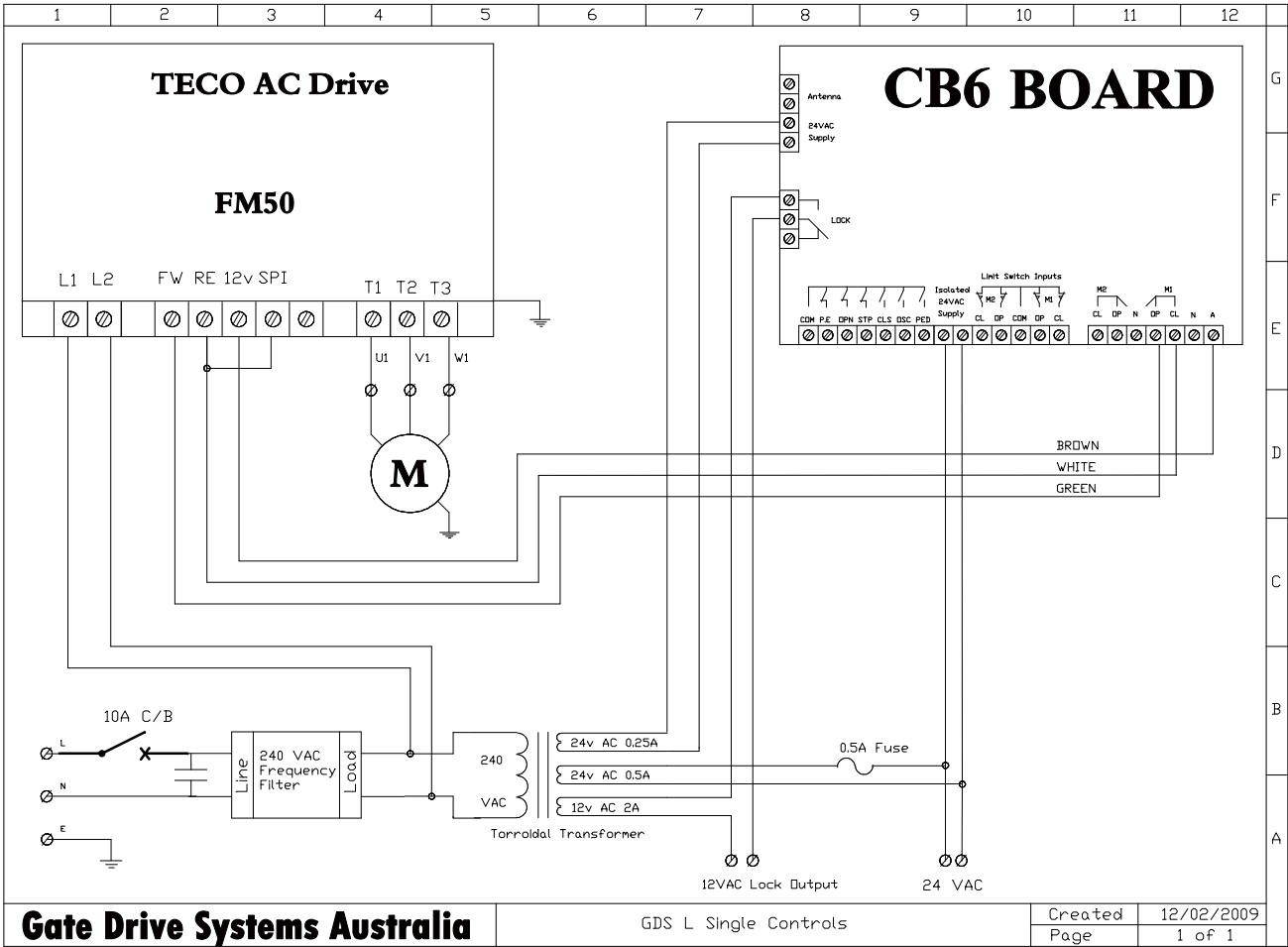

## 7. MANUAL RELEASE INSTRUCTIONS

Place key in door lock, turn clockwise till released and pull door open.



Turn knurled knob anticlockwise approx. ½ a turn to release

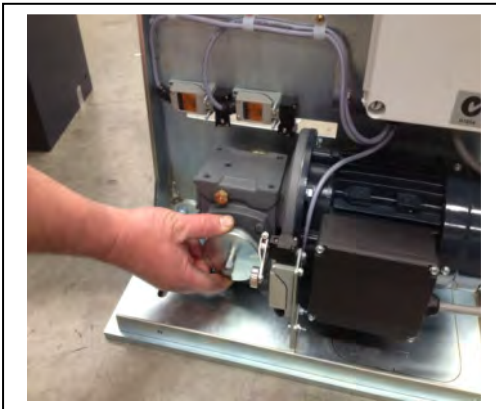

Gate can now be opened by hand.

To re-engage the clutch, move the gate by hand into approx. The half way position and turn the Knurled knob clockwise until it is very tight. If, when turning the knurled knob clockwise and it just spins, either, try spinning it clockwise with more force to release it off of the hexagonal retaining nut or hold the nut with one hand and turn the knurled knob clockwise.

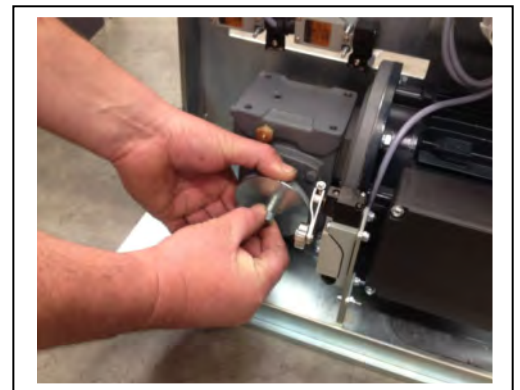



## 5. MAINTENANCE DETAILS



### WARNING!

**Failure to maintain equipment may result in injury or death and/or damage to property and equipment**

Recommended maintenance to be performed on the operator and gate are as follows:-

Operator performs over 150 cycles a day	each month
Operator performs between 100-150 cycles a day	every 2 month
Operator performs between 50-99 cycles a day	every 4 months
Operator performs between 20-49 cycles a day	every 6 months
Operator performs under 20 cycles a day	every 12 months

Date: .....

Site Name: .....

Site Address: .....

**Before** commencing maintenance on the operator, isolate the electrical supply to ensure operator will not run inadvertently.

- Gate rolls freely when in manual .....
- Gate wheels and guide rollers in good condition .....
- Gate stops are installed and in good condition, not loose .....
- Gate rack is tight & correct clearances between pinion wheel & rack.....
- Gate track is not damaged .....
- Gate operator mounting bolts tight.....
- No oil leaks from gearboxes.....
- Gearbox mounting bolts/nuts tight.....
- Inside operator and control box clean .....
- 'Baygon' Surface Spray around operator and control box (not on electronics).....
- All electrical connections tight.....
- Limit Switches operate in appropriate positions / chain oiled .....
- External safety devices work effectively / cleaned .....
- Electromagnetic lock, if fitted, operates correctly and is clean .....
- Wash down of control box and cover (particularly near corrosive/sea environments)...
- General operation i.e. speed, auto close etc normal .....

Comments.....

.....

.....

Service performed by :.....

## **6. WARRANTY**

- a. Gate Drive Systems Australia warrants that the goods manufactured by it shall be free from defect in manufacture for a period of 12 months from the date of invoice. Should any fault occur within that period as a result of faulty workmanship or materials, Gate Drive Systems Australia at its discretion, replace the product at no charge to the Customer except for removal, installation & freight. The appropriate Serial Number must be quoted for all warranty claims.
- b. For the goods not manufactured by Gate Drive Systems Australia, we shall pass on the manufacturer's warranty to the Customer from the date of invoice. It is the manufacturer's discretion to repair or replace goods deemed to be defective as a result of faulty workmanship or materials.
- c. All goods must be returned to Gate Drive Systems Australia or its representative for inspection or testing to assess if a claim is justified. It is the responsibility and at the cost of the Customer, to remove & return the goods for inspection and freight costs are the responsibility of the Customer.
- d. The warranty is negated and will not apply in the following circumstances:-
  - i. If no proof of date of purchase can be produced.
  - ii. If the product has been used in a manner beyond its design parameters.
  - iii. If the product is tampered with or repaired by personnel not authorised to do so.
  - iv. In respect of loss or damage caused by rough treatment.
  - v. If the product is not used and maintained in accordance with instructions or recommendations listed in this Installation and Maintenance Manual.
  - vi. In respect of loss or damage caused by an Act of God or any other cause not within the manufacturers control.
- e. Goods returned under warranty for repair or testing will incur a charge to be fixed by the manufacturer if no fault is found.
- f. The Customer shall bear freight charges for removing & returning the goods for inspection and for the delivery & installation of any replacement or repaired product from a justified warranty claim.
- g. Save for the express conditions and warranties herein contained all other conditions or warranties (whether as the quality, fitness for purpose or any other matter) expressed or implied by statute, common law, equity, trade custom, usage or otherwise are hereby expressly excluded provided that nothing in these terms and conditions shall exclude or limit any breach or condition implied by law, the exclusion or limitation of which is not permitted by law.